

# TUBUS TR-H Profile Dampers

**Compact size with soft deceleration and high force absorption**

**Radial damping, hard version**

**Energy capacity 2.7 Nm/cycle to 427 Nm/cycle**

**Maximum stroke 15 mm to 56 mm**

## TR-H



The identification numbers listed are the respective standard units of the corresponding damper series. Special types can have deviating identification numbers.

Table of contents	Page
General instructions.....	2
Safety information .....	2
Intended use.....	2
Description and function.....	2
Calculation and design .....	2
Delivery and storage .....	2
Maintenance and care .....	2
Disassembly and disposal.....	2
Mounting instructions.....	3
Warranty .....	4
Expected service life .....	4
Technical data.....	4

## General instructions

This manual is for the disruption-free use of the product types listed on page 1; its compliance is a prerequisite for the fulfilment of any warranty claims.

Therefore, make sure to read this manual before use.

Please always maintain the specified limits from the performance table (technical data). Take into account the predominant environmental conditions and restrictions. Note the regulations of the trade association, TÜV or corresponding national, international and European regulations. Installation and commissioning only according to mounting instructions.

## Safety information

### WARNING



If TUBUS profile dampers are used where a failure of the product could lead to personal injuries and/or material damage, additional safety elements must be implemented.



Free-moving masses can lead to injuries by crushing during installation of the profile damper. Secure moving masses against inadvertent starting with suitable safety precautions before installing the profile damper.

## Intended use

ACE profile dampers are an alternative product to the hydraulic end position damper. They are used wherever moving masses do not have to be accurately stopped and the energy does not have to be completely absorbed. The reversible profile dampers are intended for emergency stop and continuous uses. The TUBUS profile dampers of the TR-H range are designed for force absorption in an radial direction.

## Description and function

The TR-H profile dampers of the ACE TUBUS series are maintenance-free, ready-to-install damping elements made from a co-polyester elastomer. Like the TR standard model, they are radially loaded and therefore allow a very long and soft deceleration. Thanks to a harder material mixture the TR-H series offers a significantly higher energy capacity. The energy absorption is between 39 % and 62 %.

A structural change in the production process of these damping elements creates a defined preloading, whereby the TUBUS converts the occurring force into heat through friction.

One part of the occurring energy is therefore absorbed, whilst the other part is released again by the return of the body to its original position.

## Calculation and design

In order to ensure an optimum, fault-free and durable function of the TUBUS Profile Dampers they must be correctly dimensioned and designed. The following parameters must be known and used in the calculation:

- Moving mass [kg]
- Impact velocity of the mass into the profile damper(s) [m/s]
- Additionally acting propelling force, propelling power or propelling torque [N, kW, Nm]
- Number of profile dampers acting in parallel [n]
- Number of strokes or cycles per hour [1/h]

The dampers must be dimensioned in such a way that the maximum energy capacity per stroke is not exceeded during continuous duty or for emergency stop applications. The specified performance data and dimensions for the profile damper type used can be found in the performance table. The correct size of the profile dampers for emergency stop applications can be determined with the ACE online calculation programme at [www.ace-ace.com](http://www.ace-ace.com). The calculations are based on dynamic loads. Where necessary we will also happily send you the respective dynamic and static characteristic curves. You can also send us the completed online form by email for checking.

Or make use of our free calculation service by phoning: +49 (0)2173 9226 20

## Delivery and storage

The profile damper can become damaged when opening the packaging. Do not use cutting tools if possible.

- After delivery please check the profile dampers for any damage.
- Profile dampers can generally be stored in any position.

## Maintenance and care

Profile dampers are made from one part and therefore do not need any special maintenance. Profile dampers that are not regularly operated (e.g. emergency stop devices) are checked at least once per year as part of the normal safety check of the plant. The surface is to be checked for cracks and deformations and the mounting elements checked that they are properly secured. For profile dampers that are regularly operated, these checks should take place at intervals of no more than three months.

What should be noted after a damper impact?

Profile dampers that are not regularly operated are to be checked after a damper impact.

## Disassembly and disposal

The profile damper is 100 % recyclable and can be discarded in household waste.

## Example:

### Type TR95-50H characteristic curve

#### Energy stroke characteristic curve (dynamic)

(With impact velocity range over 0.5 m/s)

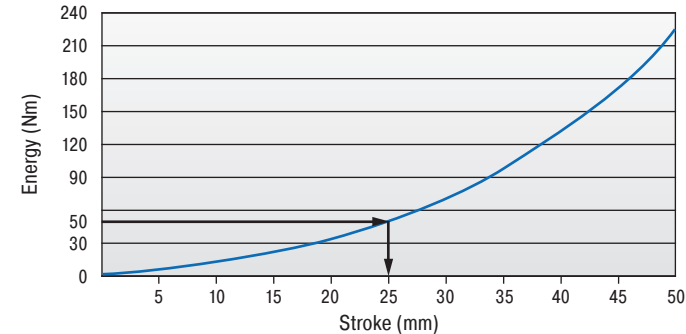

#### Force stroke characteristic curve (dynamic)

(With impact velocity range over 0.5 m/s)

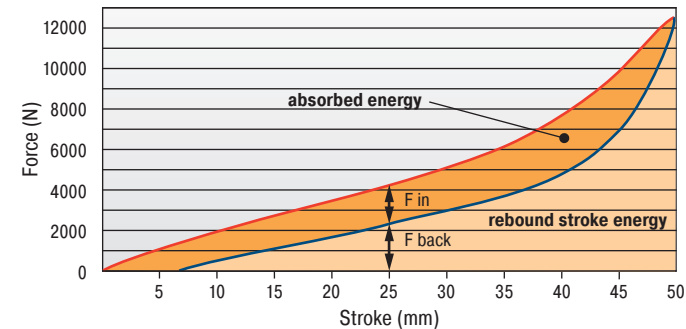

The total energy and its absorbed portion can be determined from the selection charts.











Example: Energy to be absorbed 50 Nm = stroke used 25 mm see example energy stroke characteristic curve.

At the force stroke characteristic curve the determined stroke can be used to determine the share of absorbed or returned force.

**Dynamic ( $v > 0.5$  m/s) and static ( $v \leq 0.5$  m/s) characteristic curves available for all types on request.**

## Mounting instructions and mounting accessories

### WARNING

-  A failure of the product can lead to personal injuries and/or material damage. Use additional safety elements.
-  During installation/disassembly of the profile dampers, moving masses can lead to injuries due to inadvertent starting. Secure moving masses against inadvertent moving.
-  The profile dampers may be unsuitable for use and have an insufficient damping effect. Before installation check the correct size of the dampers using the field data, performance table (page 4) and calculations. The energy capacity per stroke during continuous duty and for emergency stop applications may not be exceeded (see performance table).
-  The profile damper can tear off upon impact. Always lay out the connection structure in such a way that the maximum occurring forces can be absorbed with sufficient safety. The maximum reacting forces Q listed in the calculations may deviate from the actually occurring reacting forces, as these are based on theoretical values.
-  The profile dampers may be unsuitable for use as a rebound effect can occur. Note that the moving mass is not accurately braked and the energy is not completely absorbed. A limited application range is therefore to be observed for the following drive types: toothed belt drive, threaded spindle drive, drive with gears. The maximum return forces listed in the calculations may deviate from the actually occurring return forces, as these are based on theoretical values.
-  Exceeding or falling below the maximum or minimum temperature can lead to the destruction of the damper material and the profile damper could lose its function. Maintain the operating temperature range of -40 °C to +90 °C.
-  Fluids or aggressive media in the surrounding area can attack or destroy the material of the profile damper and cause it to fail. Insulate the "external materials" in the area around the profile damper. Note the chemical resistance list.
-  Impact velocity that is too high can lead to damage to the profile damper and failure. Note the maximum impact velocity of 5 m/s.
-  The profile dampers for emergency stop may be unsuitable for continued use after one impact. Profile dampers that are not regularly operated (e.g. for emergency stop devices) are to be checked after a damper impact.
-  Damage to the surface by other external influences can lead to an insufficient damping and to a premature failure of the profile damper. We recommend regularly checking the surface for cracks and deformations as well as checking the mounting elements are properly secured. Check emergency stop devices at least once per year and, in the case of continuous duty, at intervals of a maximum of three months.
-  Please mount the dampers in such a way that there is sufficient room for the max. compressed external diameter. The moving mass should have at least the same diameter so that it does not buckle or crack.

### Installation instructions

Before installation and use check whether the identification number on the damper or on the packaging matches the respective designation on the delivery note. Profile dampers are maintenance-free and ready to install.

**Operating temperature range:** -40 °C to +90 °C

**Temperature effect:** The  $W_3$  values given in the performance table are valid for room temperature in the environment. At higher temperatures the energy capacity per stroke is reduced.

**Mounting:** in any position, however, always in such a way that the impact surface of the profile damper is evenly loaded. A side load angle between profile damper and occurring mass is to be avoided as transverse forces can lead to tearing off or permanent deformation of the damper.

The outer diameter of the damper increases upon impact. Note the max. compressed diameter ( $d_c$ ) listed in the table. The moving mass should have at least the same diameter so that the entire impact surface is loaded.

**Mounting information:** To mount the damper we recommend the use of original ACE mounting screws. The listed maximum torque is to be observed. Please also check the thread length ( $L_M$ ) along with all further dimensions listed in the table.

### Permissible torque of mounting screw:

- M5: 3 Nm
- M6: 6 Nm
- M8: 20 Nm

**Note:** For seawater applications please use stainless steel bolts – these are not included.

### Packaging disposal

Please dispose of the transportation packaging in an environmentally-friendly manner. Recycling packaging materials saves raw materials and reduces waste. The packaging materials do not contain any prohibited materials.

### TR-H

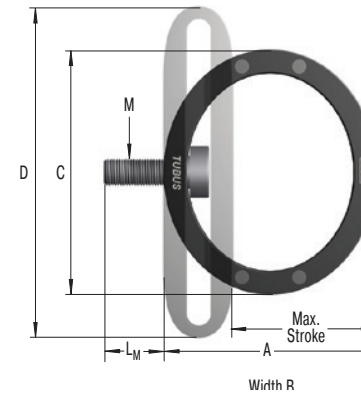

### Performance data and dimensions

TYPES	Emergency stop		Stroke max. mm	A mm	B mm	C mm	D mm	$L_M$ mm	M	Weight kg
	<sup>1</sup> $W_3$ Nm/cycle	$W_3$ Nm/cycle								
TR30-15H	2.7	5.7	15	23	13	30	38	5	M5	0.009
TR39-19H	6.0	18.0	19	30	19	39	50	5	M5	0.013
TR45-23H	8.7	24.0	23	36	20	45	58	5	M5	0.019
TR52-32H	11.7	20.0	32	42	34	52	68	5	M5	0.030
TR64-41H	25.0	46.0	41	53	43	64	87	5	M5	0.054
TR68-37H	66.5	98.0	37	56	46	68	88	5	M5	0.095
TR79-42H	81.5	106.0	42	64	46	79	102	6	M6	0.107
TR86-45H	124.0	206.0	45	69	51	86	109	6	M6	0.152
TR87-46H	158.0	261.0	46	68	67	86	111	8	M8	0.188
TR95-50H	228.0	342.0	50	77	82	95	124	8	M8	0.281
TR102-56H	290.0	427.0	56	84	81	102	133	8	M8	0.334

<sup>1</sup> Energy capacity per stroke during continuous duty.

All data are nominal dimensions. Tolerances are available on request.

## Manual

### Warranty

Fundamentally, all modifications to the product by third parties lead to exclusion from the warranty.

Obvious defects must be reported to the vendor in writing immediately after delivery, no later than one week, but in any case before processing or installation, otherwise the assertion of a warranty claim is excluded. A timely dispatch is sufficient to keep the term.

The vendor is to be given an opportunity to check on site. If the complaint is justified the vendor offers warranty by repair or replacement at its own discretion. If the rectification fails, the buyer may choose to demand reduction of payment or cancellation of the contract. If there is only a minor lack of conformity, particularly with only minor defects, the buyer nevertheless has a right of withdrawal.

If, after failed rectification, the buyer chooses to cancel the contract due to a defect of title or material defect, they are not entitled to additionally claim for damages.

If, after failed fulfilment, the buyer chooses compensation, the goods remain with the buyer, if this is reasonable. The compensation is limited to the difference between the purchase price and the value of the defective item. This does not apply if the vendor maliciously causes the breach of contract.

The quality of the goods is only considered as agreed upon with the product description of the vendor. Public statements, claims or advertising of the manufacturer do not represent an additional contractual specification of quality of the goods.

If the buyer receives defective mounting instructions, the buyer is only obligated to deliver defect-free mounting instructions and only if the defect to the mounting instructions prevents proper mounting.

The warranty period is two years and begins upon completion. Exchange and return of custom products are fundamentally excluded. The factory conditions of the manufacturing factory apply to parts not manufactured and processed by the vendor, which can be viewed by the orderer at the vendor at any time. Construction and installation parts are delivered according to the present standard of engineering.

### Service life

In general TUBUS profile dampers are machine elements that are subject to wear. The wear is largely dependent upon the respective application and its operating parameters.

When used under optimum conditions and maintaining the parameters specified in the performance table, a service life of up to 1 million load changes is to be expected.

### Technical data

**Energy capacity:** 2.7 Nm/cycle to 427 Nm/cycle

**Energy absorption:** 39 % to 62 %

**Dynamic force range:** 550 N to 21,200 N

**Operating temperature range:** -40 °C to +90 °C

**Construction size:** 30 mm to 102 mm

**Mounting:** in any position

Material hardness rating: Shore 55D

**Material:** Profile body: Co-polyester elastomer

**Mounting screws:** Special socket head screws with internal hex socket, zinc-plated 44Smn28 material (SAE 1144 machining steel):

**M5x8, M5x11, M5x12, M6x16, M8x20**

For seawater applications please use stainless steel bolts – these are not included.

**Environment:** Resistant to microbes, seawater or chemical attack. Excellent UV and ozone resistance.

Material does not absorb water or swell.

**Impact velocity range:** Max. 5 m/s

**Torque max.:**

M5: 3 Nm

M6: 6 Nm

M8: 20 Nm

**Application field:** Furniture industry, Sports equipment, Linear slides, Pneumatic cylinders, Handling modules, Machines and plants, Stacking units, Electro-mechanical drives, Conveyor systems

**Note:** Suitable for emergency stop applications and for continuous use. For applications with preloading and increased temperatures please consult ACE.

**Safety instructions:** Mounting screw should additionally be secured with Loctite.

**On request:** Special strokes, -characteristics, -spring rates, -sizes and -materials.