

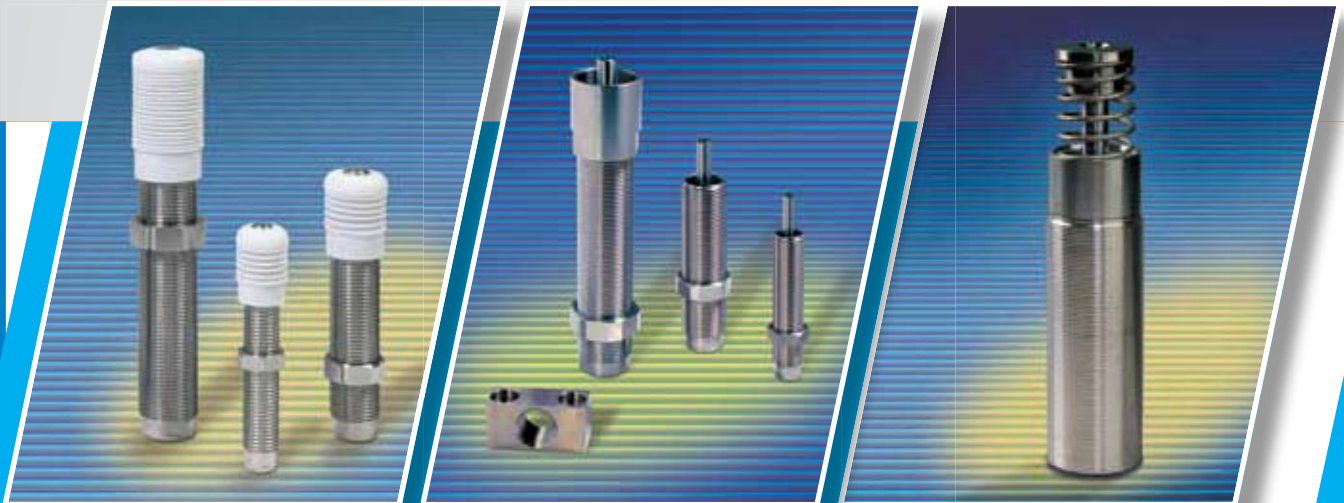

STAINLESS STEEL

INDUSTRIAL SHOCK ABSORBERS



*V4A HIGH QUALITY STAINLESS STEEL
FOR LONG LIFE APPLICATIONS*

PACKAGING / FOOD PROCESSING / MEDICAL / ELECTRONICS / CHEMICAL / MARINE / EXTREME ENVIRONMENTS

Based on the proven damping technology of the MC150 to 600 series, these self-adjusting ACE miniature shock absorbers are offered in stainless steel. The outer body, hardened piston rod and all accessories are made of V4A (material 1.4404). The **MC 150 to MC 600-V4A series** is therefore ideally suited for applications in medical technology, the food and packaging industry, electronics, dock side installations and marine industries. These special dampers offer all the advantages of the MC standard series. The ACE rolling seal membrane achieves the longest lifetime of any shock absorber and can withstand up to 7 bars when directly mounted into a pressure chamber. The wide range of models available ensure a seamless range of operation on applications with effective weights from 0.9 to 4536 kg (2 to 10,000 lbs). With an integrated positive stop and accessories also in V4A this range allows for many different application possibilities. By using the option to fill types MC 150 to 600 with special oil that fulfils the requirements (NSF-H1) of the food industry there is a ready made shock absorber system ideally suited to the food processing and packaging industry.



"Also available with special oil suited for the food industry!"

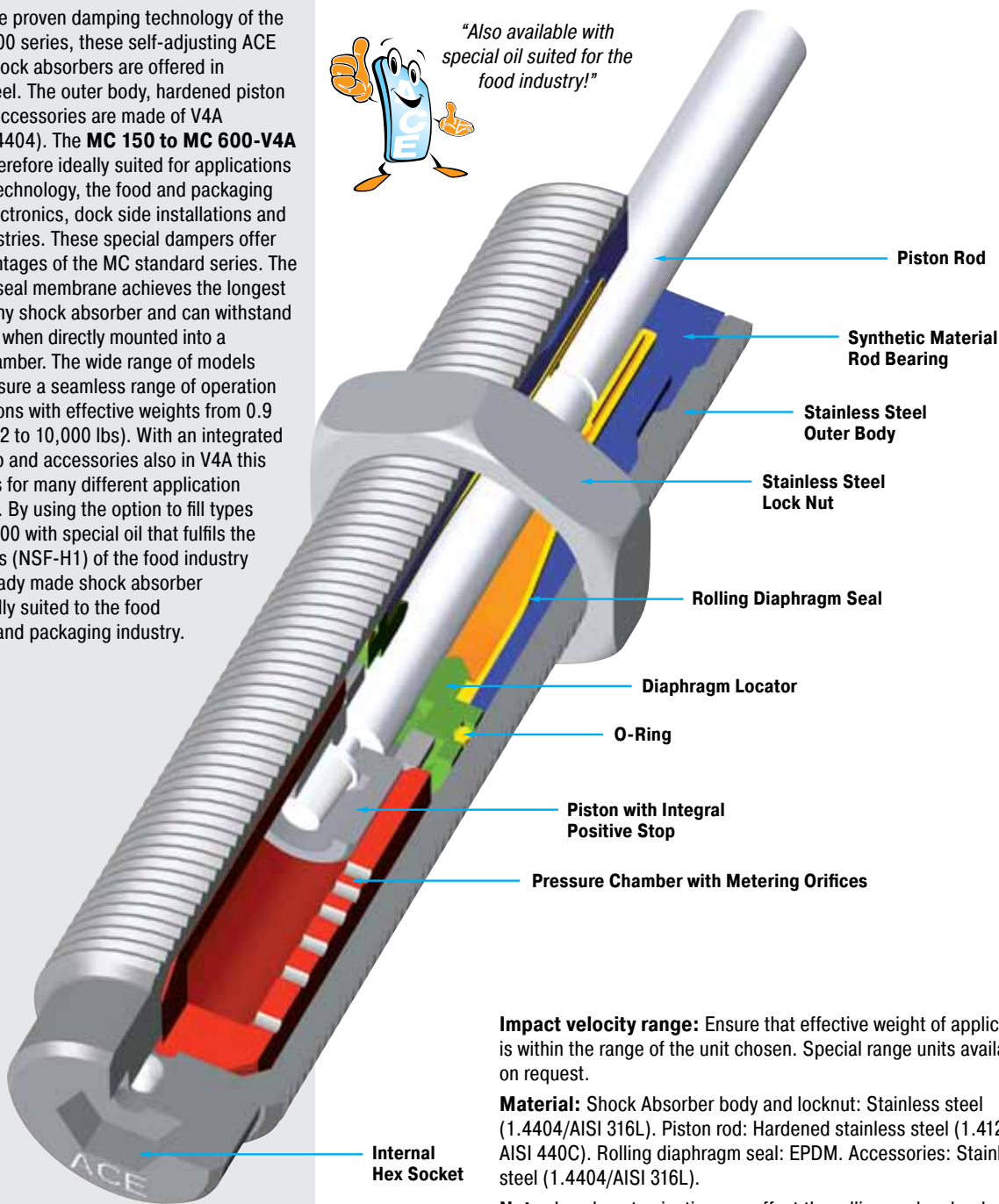

Impact velocity range: Ensure that effective weight of application is within the range of the unit chosen. Special range units available on request.

Material: Shock Absorber body and locknut: Stainless steel (1.4404/AISI 316L). Piston rod: Hardened stainless steel (1.4125/AISI 440C). Rolling diaphragm seal: EPDM. Accessories: Stainless steel (1.4404/AISI 316L).

Note: Local contamination can affect the rolling seal and reduce the lifetime. Please contact ACE for a suitable solution.

W₄ capacity rating: (max. energy per hour Nm/hr) If your application exceeds the tabulated W₄ figures consider additional cooling i.e. cylinder exhaust air etc. Ask ACE for further details.

Mounting: In any position. If precise end position datum is required consider use of the optional stop collar type AH.

Operating temperature range: 0°C to 66°C (32°F to 150°F)

On request: Special oils, seals and special accessories.



MC 150M-V4A

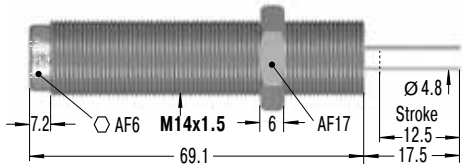

PP150

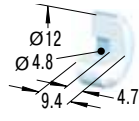

Nylon Button
W₃ max = 14 Nm

AH14-V4A

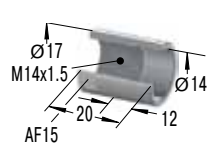

Stop Collar

MB14SC2-V4A

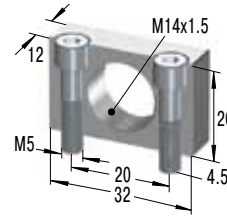

Mounting Block

KM14-V4A

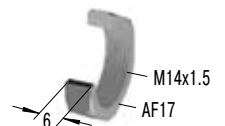

Locknut

MC 225M-V4A

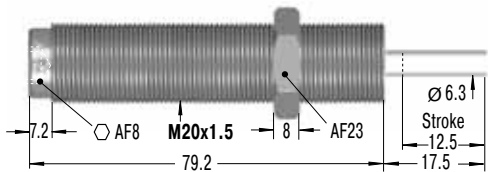

PP225

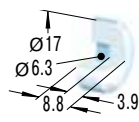

Nylon Button
W₃ max = 33 Nm

AH20-V4A

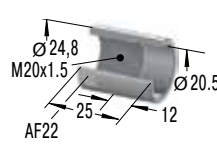

Stop Collar

MB20SC2-V4A

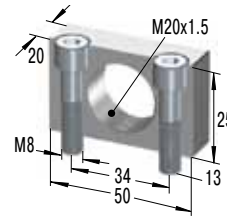

Mounting Block

KM20-V4A



Locknut

MC 600M-V4A

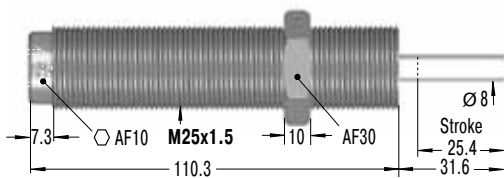

PP600

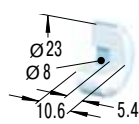

Nylon Button
W₃ max = 68 Nm

AH25-V4A

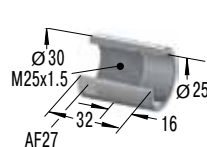

Stop Collar

MB25SC2-V4A

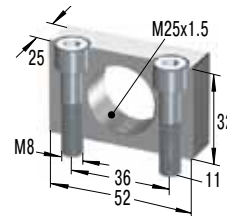

Mounting Block

KM25-V4A



Locknut

Capacity Chart

¹ For applications with higher side load angles please contact ACE.

Metric	Max. Energy Capacity		Effective Weight me		Min. Return Force	Max. Return Force	Rod Reset Time	¹ Max. Side Load Angle	Weight
	W ₃	W ₄	me min.	me max.					
Type	Nm/Cycle	Nm/h	kg	kg	N	N	s	°	kg
MC 150M-V4A	20	34 000	0.9	10	3	5	0.4	4	0.06
MC 150MH-V4A	20	34 000	8.6	86	3	5	0.4	4	0.06
MC 150MH2-V4A	20	34 000	70	200	3	5	0.4	4	0.06
MC 150MH3-V4A	20	34 000	181	408	3	5	1	4	0.06
MC 225M-V4A	41	45 000	2.3	25	4	6	0.3	4	0.14
MC 225MH-V4A	41	45 000	23	230	4	6	0.3	4	0.15
MC 225MH2-V4A	41	45 000	180	910	4	6	0.3	4	0.14
MC 225H3-V4A	41	45 000	816	1 814	4	6	0.3	4	0.05
MC 600M-V4A	136	68 000	9	136	5	9	0.6	2	0.27
MC 600MH-V4A	136	68 000	113	1 130	5	9	0.6	2	0.27
MC 600MH2-V4A	136	68 000	400	2 300	5	9	0.6	2	0.29
MC 600MH3-V4A	136	68 000	2 177	4 536	5	9	0.6	2	0.26

Imperial	Max. Energy Capacity		Effective Weight me		Min. Return Force	Max. Return Force	Rod Reset Time	¹ Max. Side Load Angle	Weight
	E ₃	E ₄	We min.	We max.					
Type	In. lbs/Cycle	In. lbs/h	lbs	lbs	lbs	lbs	s	°	lbs
MC 150M-V4A	175	300 000	2	22	0.7	1.2	0.4	4	0.12
MC 150MH-V4A	175	300 000	20	200	0.7	1.2	0.4	4	0.12
MC 150MH2-V4A	175	300 000	150	450	0.7	1.2	0.4	4	0.12
MC 150MH3-V4A	175	300 000	400	900	0.7	1.2	1	4	0.12
MC 225M-V4A	360	400 000	5	55	1	1.5	0.3	4	0.34
MC 225MH-V4A	360	400 000	50	500	1	1.5	0.3	4	0.34
MC 225MH2-V4A	360	400 000	400	2 000	1	1.5	0.3	4	0.34
MC 225H3-V4A	360	400 000	1 800	4 000	1	1.5	0.3	4	0.34
MC 600M-V4A	1 200	600 000	20	300	1	2	0.6	2	0.57
MC 600MH-V4A	1 200	600 000	250	2 500	1	2	0.6	2	0.57
MC 600MH2-V4A	1 200	600 000	880	5 000	1	2	0.6	2	0.57
MC 600MH3-V4A	1 200	600 000	4 800	10 000	1	2	0.6	2	0.57

These new ACE shock absorbers of the Protection series PMC were designed for applications with particular fluid requirements. The special protective cap made of PTFE (Teflon) hermetically seals the entire damping system (the proven rolling seal) against outside influences. Aggressive cutting, cooling, or cleaning agents are thus not able to contaminate the shocks inside the system. A stainless steel button integrated in the cap absorbs the impact energy reliably and establishes longest lifetimes for the shock absorber. The new Protection series offers the perfect alternative to the ACE air bleed collar of the SP series, when the machine or equipment does not possess its own compressed air. The Protection series is available for thread sizes **M14 to M25** and can find applications in all those environments where common shock absorbers cannot be used because of aggressive fluids. The Protection series is of special interest for the food industry as the shocks can be delivered with a V4A stainless (material number 1.4404) steel outer body.

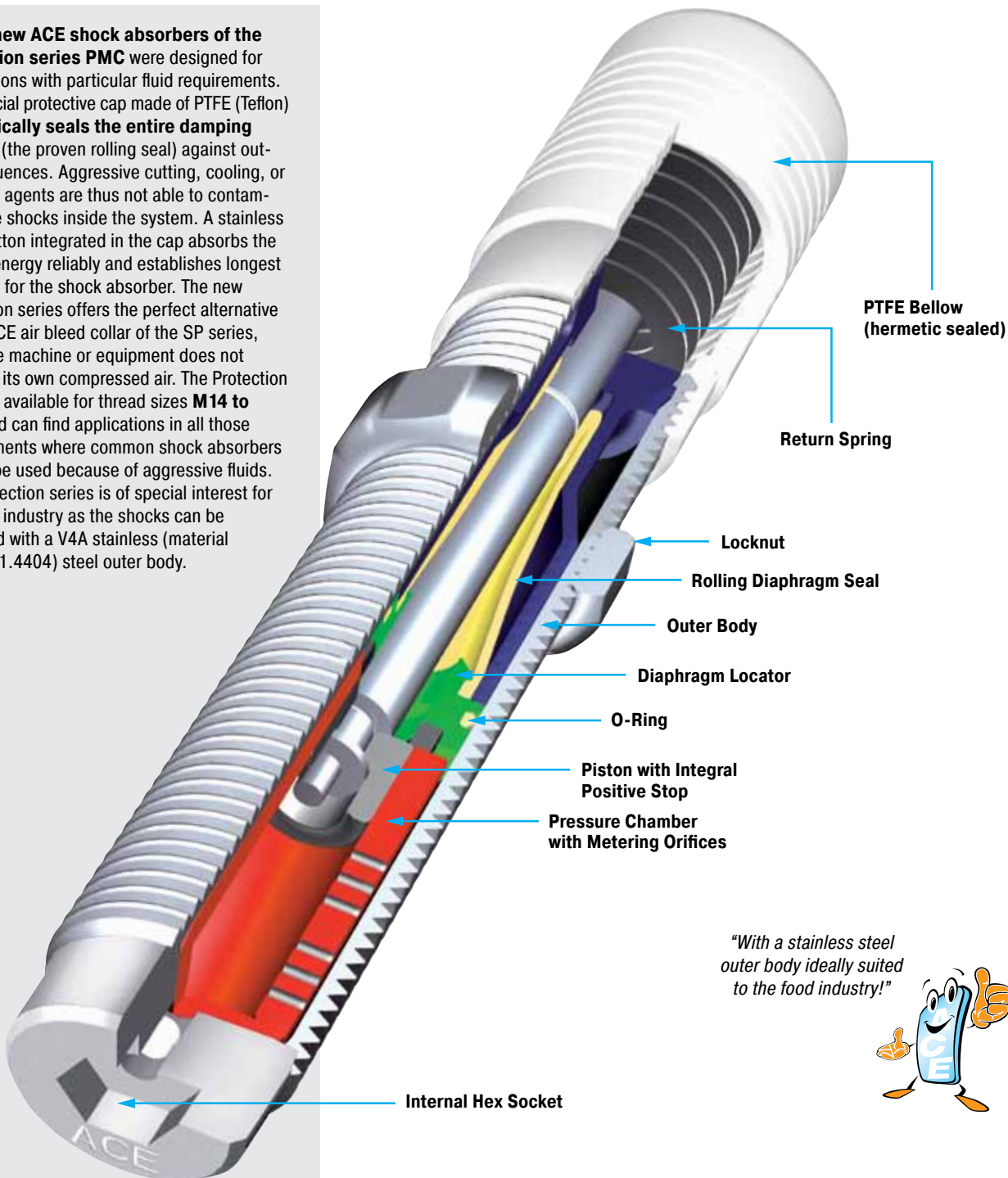

"With a stainless steel outer body ideally suited to the food industry!"



Impact velocity range: Ensure that effective weight of application is within the range of the unit chosen. Special range units available on request.

Material: Bellow: PTFE. Steel insert: Stainless Steel 1.4404/AISI 316L. Shock absorber body: stainless steel 1.4404/AISI 316L.

Note: Final preliminary test must be done on the application.

Mounting: In any position

Operating temperature range: 0°C to 66°C (32°F to 150°F)



PMC 150M-V4A

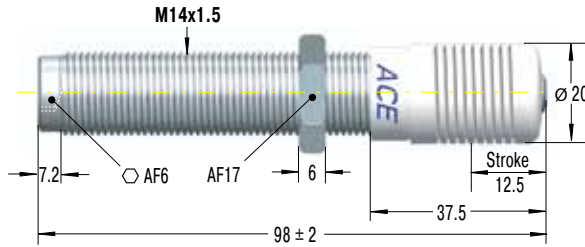

PMC 225M-V4A

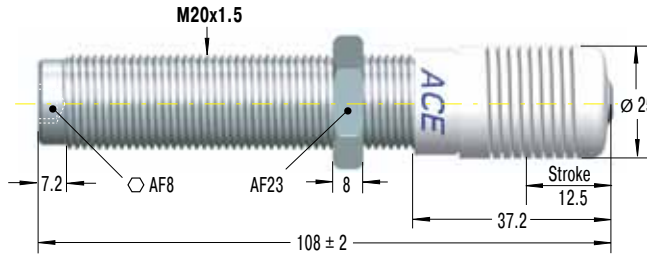

PMC 600M-V4A

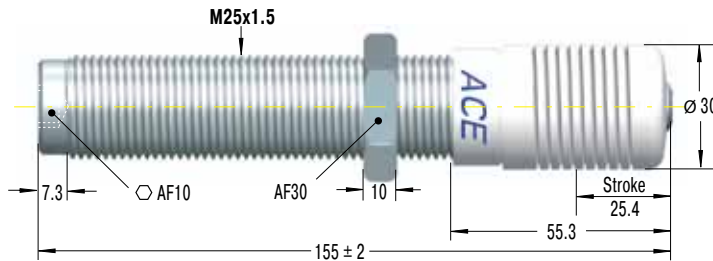

Capacity Chart

Metric	Max. Energy Capacity		Effective Weight me		Min. Return Force	Max. Return Force	Rod Reset Time	Max. Side Load Angle	Weight
	W ₃	W ₄	me min.	me max.					
Type	Nm/Cycle	Nm/h	kg	kg	N	N	s	°	kg
PMC 150M-V4A	20	34 000	0.9	10	5	60	0.4	4	0.06
PMC 150MH-V4A	20	34 000	8.6	86	5	60	0.4	4	0.06
PMC 150MH2-V4A	20	34 000	70	200	5	60	0.4	4	0.06
PMC 150MH3-V4A	20	34 000	181	408	5	60	1	4	0.06
PMC 225M-V4A	41	45 000	2.3	25	5	65	0.3	4	0.15
PMC 225MH-V4A	41	45 000	23	230	5	65	0.3	4	0.15
PMC 225MH2-V4A	41	45 000	180	910	5	65	0.3	4	0.15
PMC 225MH3-V4A	41	45 000	816	1 814	5	65	0.3	4	0.15
PMC 600M-V4A	136	68 000	9	136	5	85	0.6	2	0.30
PMC 600MH-V4A	136	68 000	113	1 130	5	85	0.6	2	0.30
PMC 600MH2-V4A	136	68 000	400	2 300	5	85	0.6	2	0.30
PMC 600MH3-V4A	136	68 000	2 177	4 536	5	85	0.6	2	0.30

Imperial

Type	E ₃	E ₄	We min.	We max.	Min. Return Force	Max. Return Force	Rod Reset Time	Max. Side Load Angle	Weight
	In. lbs/Cycle	In. lbs/h	lbs	lbs	lbs	lbs	s	°	lbs
PMC 150M-V4A	175	300 000	2	22	1	13	0.4	4	0.13
PMC 150MH-V4A	175	300 000	20	200	1	13	0.4	4	0.13
PMC 150MH2-V4A	175	300 000	150	450	1	13	0.4	4	0.13
PMC 150MH3-V4A	175	300 000	400	900	1	13	1	4	0.13
PMC 225M-V4A	360	400 000	5	55	1	14	0.3	4	0.33
PMC 225MH-V4A	360	400 000	50	500	1	14	0.3	4	0.33
PMC 225MH2-V4A	360	400 000	400	2 000	1	14	0.3	4	0.33
PMC 225MH3-V4A	360	400 000	1 800	4 000	1	14	0.3	4	0.33
PMC 600M-V4A	1 200	600 000	20	300	1	19	0.6	2	0.66
PMC 600MH-V4A	1 200	600 000	250	2 500	1	19	0.6	2	0.66
PMC 600MH2-V4A	1 200	600 000	880	5 000	1	19	0.6	2	0.66
PMC 600MH3-V4A	1 200	600 000	4 800	10 000	1	19	0.6	2	0.66

Based on the successful damping technology of our MAGNUM-Series, ACE offers this self-adjusting industrial shock absorber in complete **stainless steel design**. All outer parts, such as outer body, stop collar, and main bearing are manufactured of **V4A (material spec. number 1.4404)**. The MAGNUM VA series is therefore ideally suited for applications within the fields of medical technology, the food industry, electronics and the marine and associated industries. The **MAGNUM VA series** offers all the proven advantages of the MAGNUM standard series, like its robust and most modern seal technology, the highest energy absorption in a compact design, an integrated mechanical stop, and a wide range of effective weights. This series is available in thread sizes M33x1.5 to M64x2 with stroke lengths of up to 100 mm. The MAGNUM VA series also offers a rod button made of V4A with a polyurethane element to reduce noise levels. Additionally all MAGNUM VA dampers are filled with a special oil that conforms to the approval requirements (NSF-H1) of the food industry ex stock.

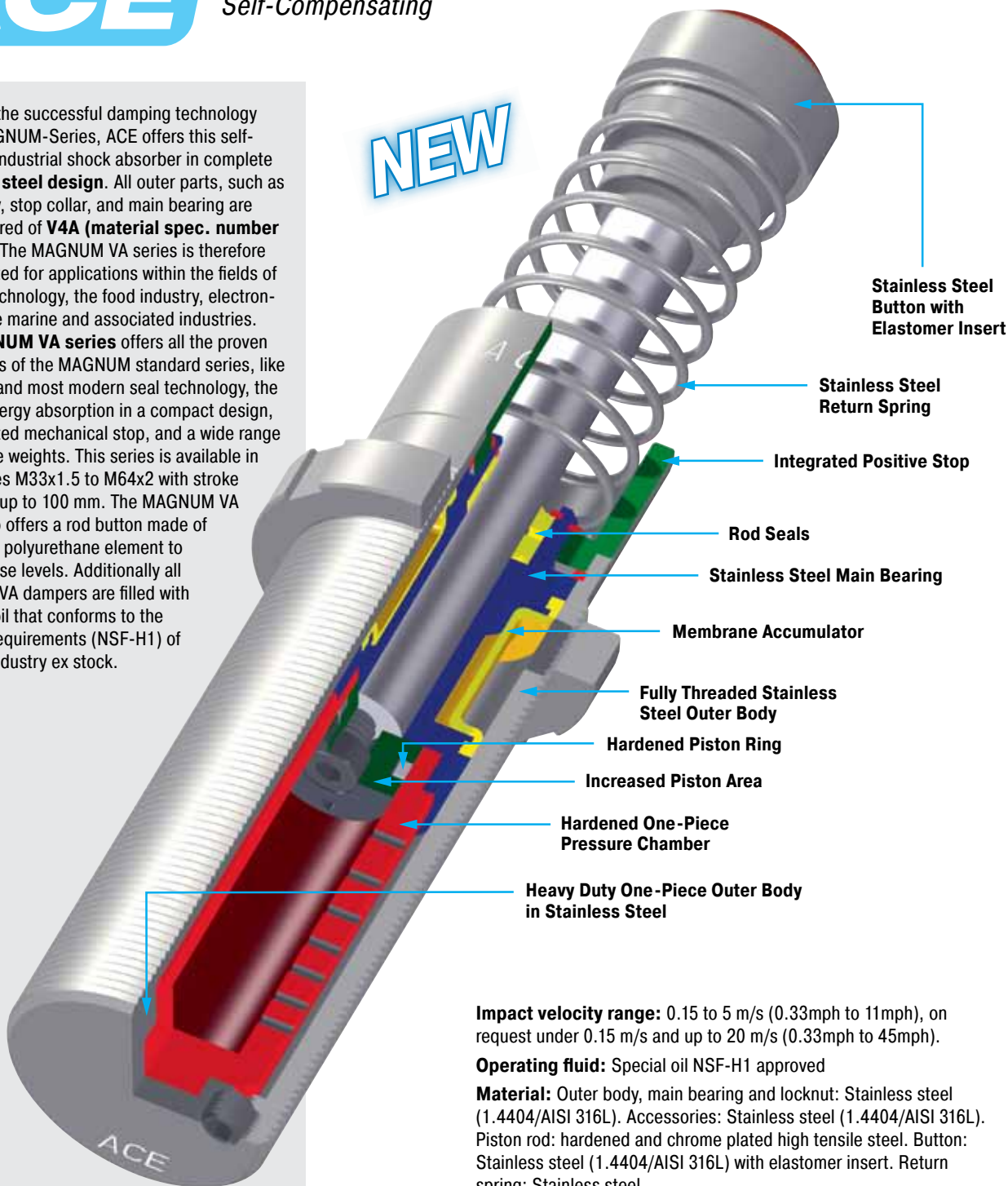

Impact velocity range: 0.15 to 5 m/s (0.33mph to 11mph), on request under 0.15 m/s and up to 20 m/s (0.33mph to 45mph).

Operating fluid: Special oil NSF-H1 approved

Material: Outer body, main bearing and locknut: Stainless steel (1.4404/AISI 316L). Accessories: Stainless steel (1.4404/AISI 316L). Piston rod: hardened and chrome plated high tensile steel. Button: Stainless steel (1.4404/AISI 316L) with elastomer insert. Return spring: Stainless steel.

Capacity rating: For emergency only applications it is sometimes possible to exceed the published max. capacity ratings. Please consult ACE for further details. If your application exceeds the tabulated W_4 figures (max. energy per hour Nm/hr) consider additional cooling. Ask ACE for further details.

Mounting: In any position

Operating temperature range: -12°C to 70°C (10°F to 158°F). For higher temperatures consult ACE.

On request: special oils, viton seals and special accessories

Noise reduction: 3 to 7 dB when using the impact buttons with urethane insert.



"Standard type with special oil NSF-H1 approved – suited for the food industry!"

NEW

Dimensions in mm

MC 33xxM-V4A

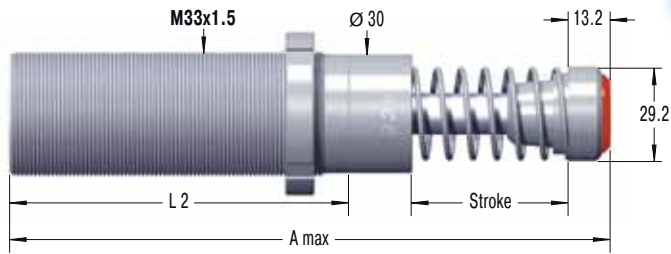

NM33-V4A

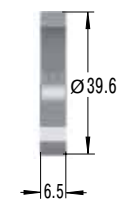

Locking Ring

QF33-V4A

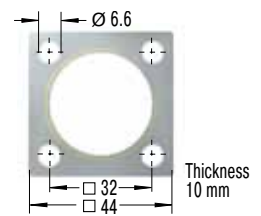

Square Flange

MC 45xxM-V4A

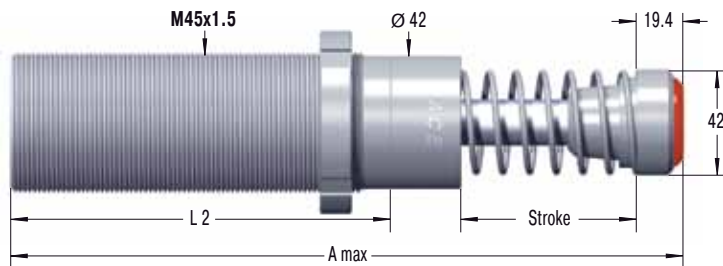

NM45-V4A

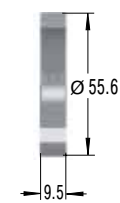

Locking Ring

QF45-V4A

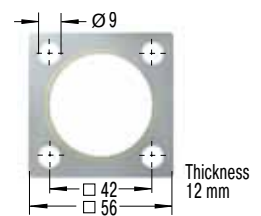

Square Flange

MC 64xxM-V4A



NM64-V4A

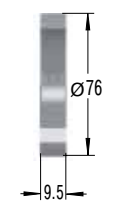

Locking Ring

QF64-V4A

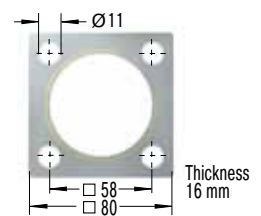

Square Flange

See back cover for additional dimensions

Capacity Chart MC 33/MC 45/MC 64

Type Self-Compensating	Max. Energy Capacity		1 Effective Weight me					Min. Return Force N	Max. Return Force N	Rod Reset Time s	Max. Side Load Angle °	Weight kg
	² W ₃ Nm/Cycle	W ₄ Nm/h	Soft		Hard							
			-0 min. max. kg	-1 min. max. kg	-2 min. max. kg	-3 min. max. kg	-4 min. max. kg					
MC 3325M-V4A	155	75 000	3 - 11	9 - 40	30 - 120	100 - 420	350 - 1 420	45	90	0.03	4	0.45
MC 3350M-V4A	310	85 000	5 - 22	18 - 70	60 - 250	240 - 840	710 - 2 830	45	135	0.06	3	0.54
MC 4525M-V4A	340	107 000	7 - 27	20 - 90	80 - 310	260 - 1 050	890 - 3 540	70	100	0.03	4	1.13
MC 4550M-V4A	680	112 000	13 - 54	45 - 180	150 - 620	520 - 2 090	1 800 - 7 100	70	145	0.08	3	1.36
MC 4575M-V4A	1 020	146 000	20 - 80	70 - 270	230 - 930	790 - 3 140	2 650 - 10 600	50	180	0.11	2	1.59
MC 6450M-V4A	1 700	146 000	35 - 140	140 - 540	460 - 1 850	1 600 - 6 300	5 300 - 21 200	90	155	0.12	4	2.9
MC 64100M-V4A	3 400	192 000	70 - 280	270 - 1 100	930 - 3 700	3 150 - 12 600	10 600 - 42 500	105	270	0.34	3	3.7

Imperial

Type Self-Compensating	² E ₃		1 Effective Weight We					Min. Return Force lbs	Max. Return Force lbs	Rod Reset Time s	Max. Side Load Angle °	Weight lbs
	In. lbs/ Cycle	In. lbs/h	Soft		Hard							
			-0 min. max. lbs	-1 min. max. lbs	-2 min. max. lbs	-3 min. max. lbs	-4 min. max. lbs					
MC 3325M-V4A	1 350	670 000	7 - 24	20 - 80	68 - 272	230 - 920	780 - 3 120	10	20	0.03	4	1
MC 3350M-V4A	2 700	760 000	11 - 49	40 - 160	136 - 544	460 - 1 840	1 560 - 6 240	10	30	0.06	3	1
MC 4525M-V4A	3 000	950 000	15 - 60	50 - 200	170 - 680	575 - 2 300	1 950 - 7 800	16	22	0.03	4	2
MC 4550M-V4A	6 000	1 000 000	29 - 119	100 - 400	340 - 1 360	1 150 - 4 600	3 900 - 15 600	16	33	0.08	3	3
MC 4575M-V4A	9 000	1 300 000	44 - 76	150 - 600	510 - 2 040	1 730 - 6 920	5 850 - 23 400	11	40	0.11	2	4
MC 6450M-V4A	15 000	1 300 000	77 - 309	300 - 1 200	1 020 - 4 080	3 460 - 13 840	11 700 - 46 800	20	35	0.12	4	6
MC 64100M-V4A	30 000	1 700 000	154 - 617	600 - 2 400	2 040 - 8 160	6 920 - 27 680	23 400 - 93 600	24	61	0.34	3	8

¹ The effective weight range limits can be raised or lowered to special order.

² For emergency only applications it is sometimes possible to exceed the above ratings. Please consult ACE for further details.

Dimensions (mm)			
Type	Stroke mm	A max	L2
MC 3325M-V4A	23	151.2	83
MC 3350M-V4A	48.5	202.2	108
MC 4525M-V4A	23	164.5	95
MC 4550M-V4A	48.5	214.4	120
MC 4575M-V4A	74	265.4	145
MC 6450M-V4A	48.5	244.1	140
MC 64100M-V4A	99.5	345.1	191

Dimensions (inches)			
Type	Stroke inches	A max	L2
MC 3325M-V4A	1	6	3
MC 3350M-V4A	2	8	4
MC 4525M-V4A	1	7	4
MC 4550M-V4A	2	8	5
MC 4575M-V4A	3	10	6
MC 6450M-V4A	2	10	6
MC 64100M-V4A	4	14	8

Ordering Example

MC 4550M-1-V4A

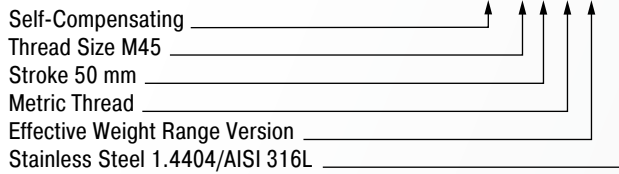

Other Deceleration and Motion Control Products



Safety Shock Absorbers



Velocity and Feed Controllers



PET and GLASS Shock Absorbers



TUBUS Bumpers



Gas Springs



Rotary Dampers



Hydraulic Dampers